

FIG. 1

www.google.com

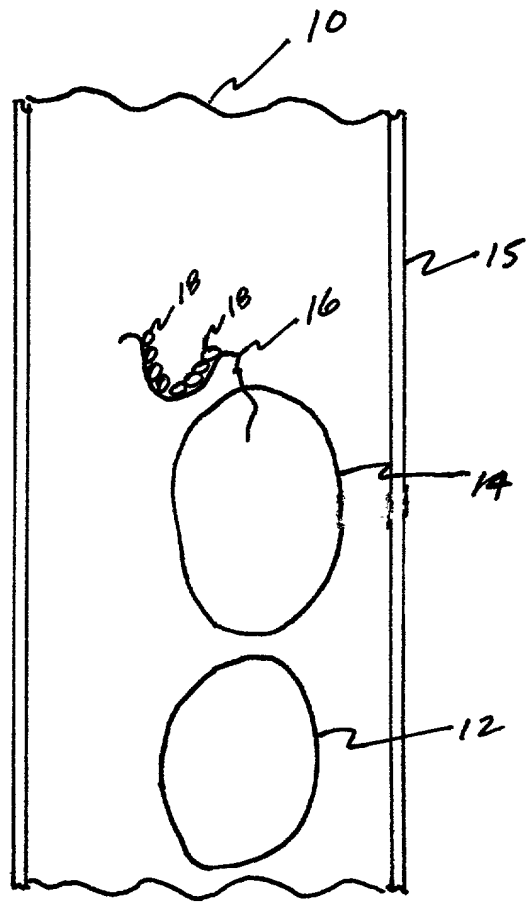

Fig. 2

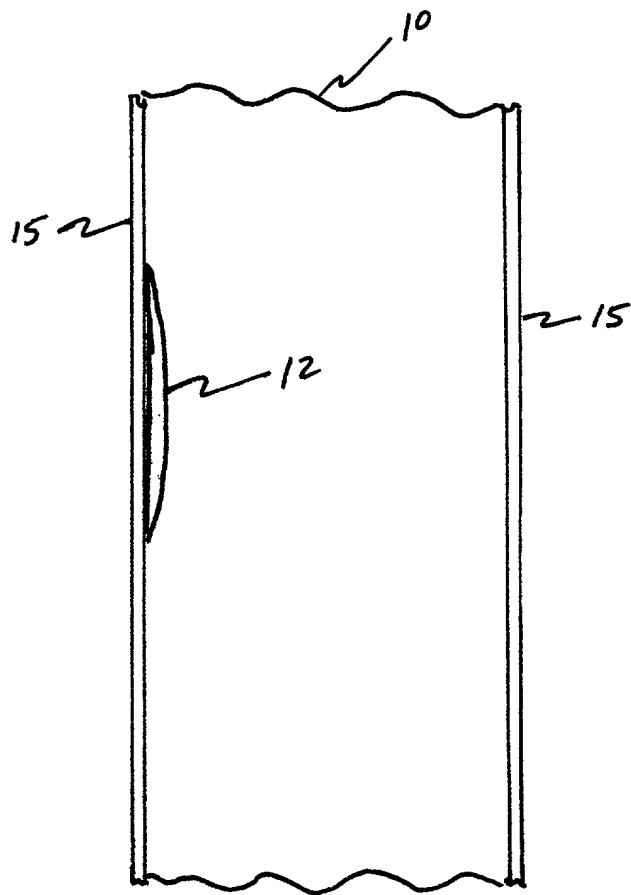

Fig. 3

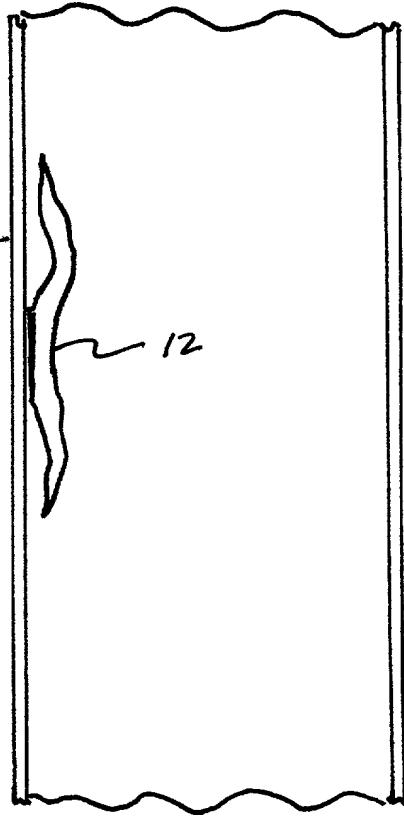

Fig. 4

WORLD PATENT

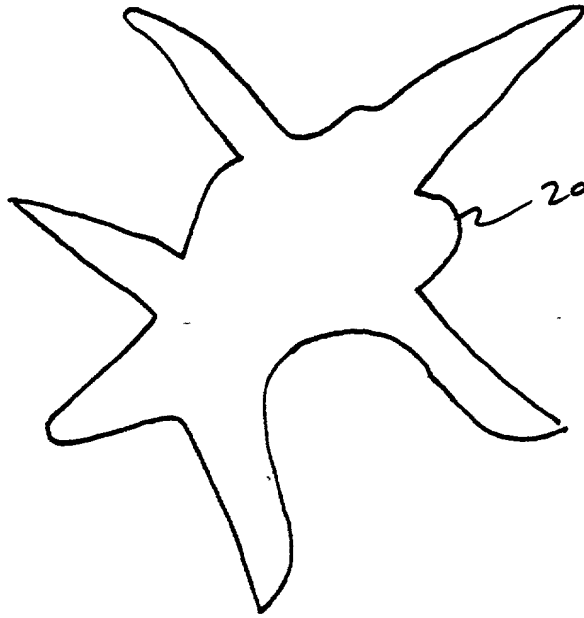

Fig. 5

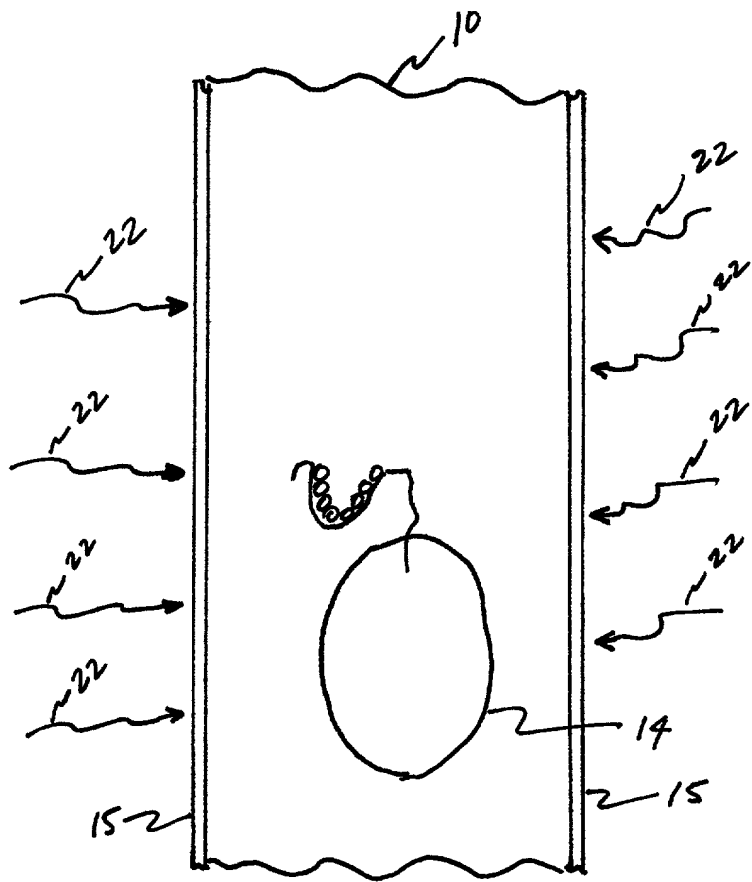

Fig. 6

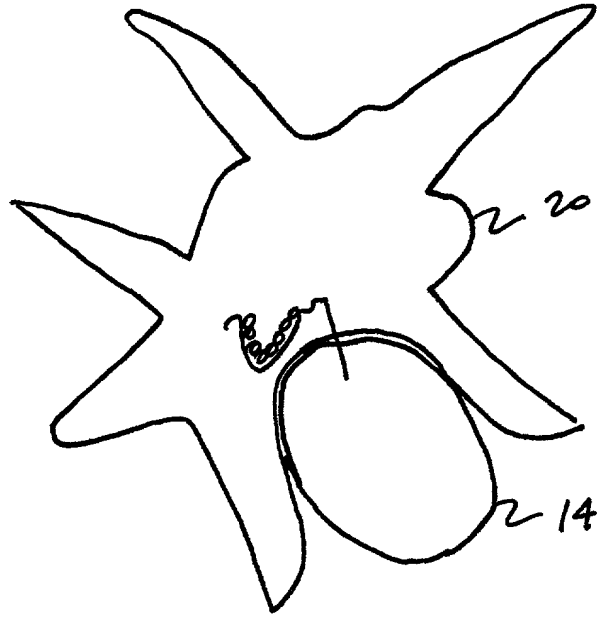

Fig. 7

U.S. PAT. OFF. DRAWING

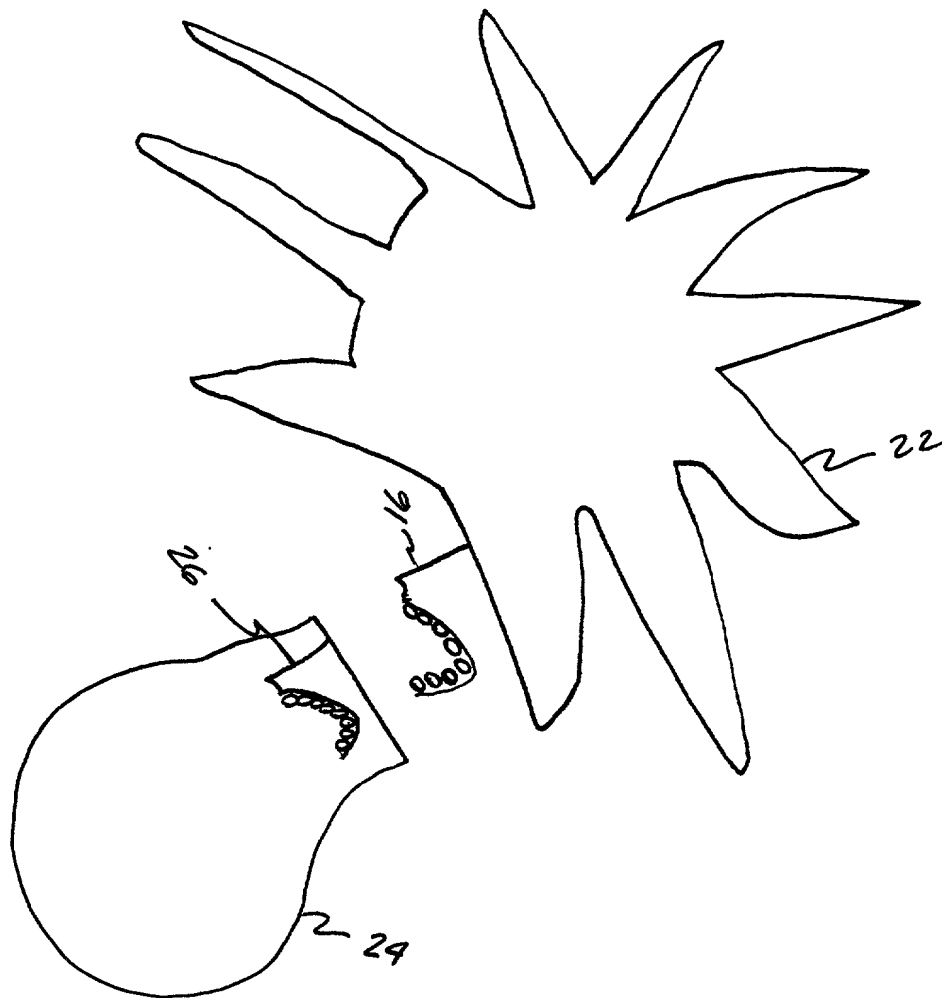

Fig. 8



FIG. 9

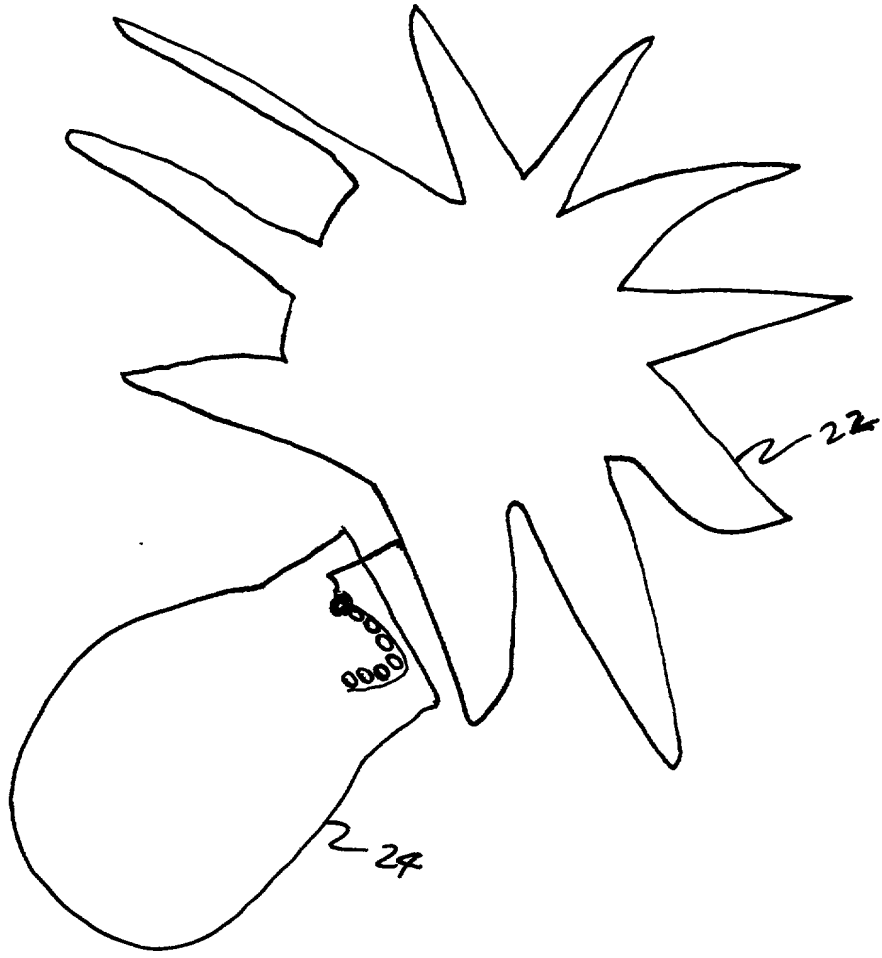

Fig. 9

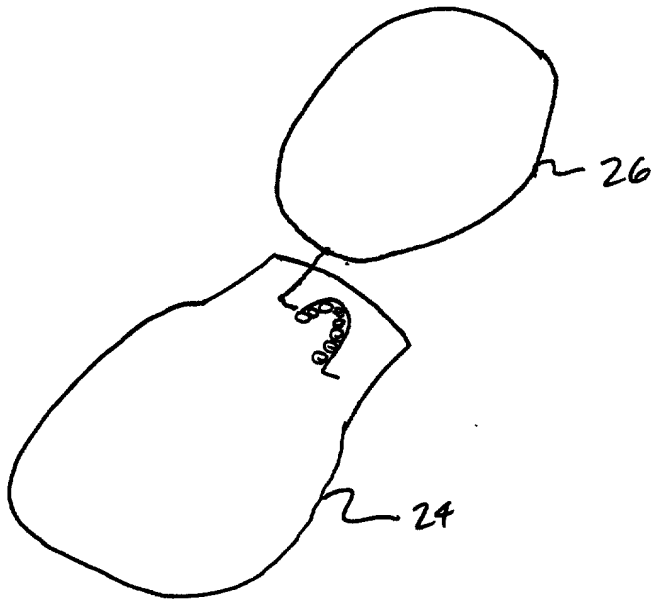

Fig. 10